

Packing List/User Guide



Planter Box



Mounting Bracket

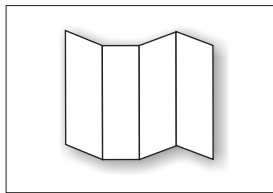

User Guide



SmartStrap™ and Grip Bands

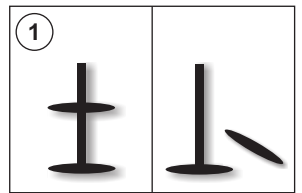

Packing Clip - Discard

3" to 14" *round and square*

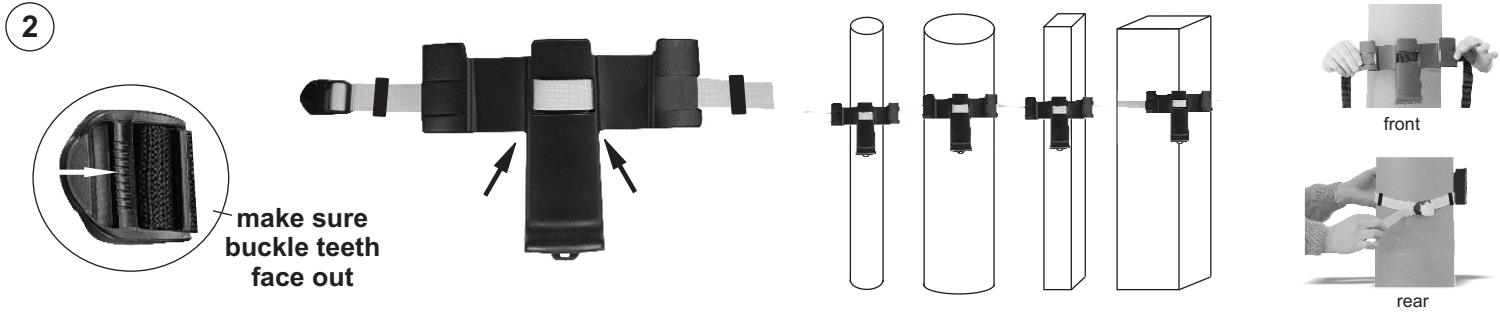

Thread SmartStrap™ >> CENTER SLOTS ONLY <<, Position Grip Bands, Buckle and Mount Bracket

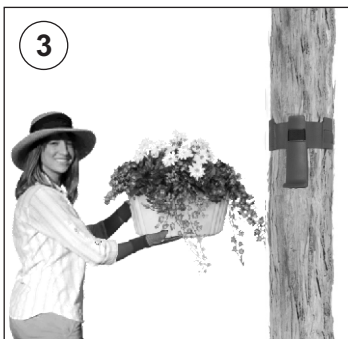

3
Fill HugIt® Planter and Slide on Bracket

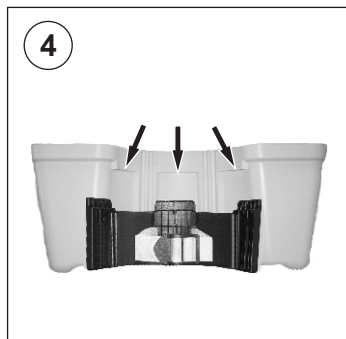

4
Slide Planter onto Bracket



5
Water & Feed Plants as Needed

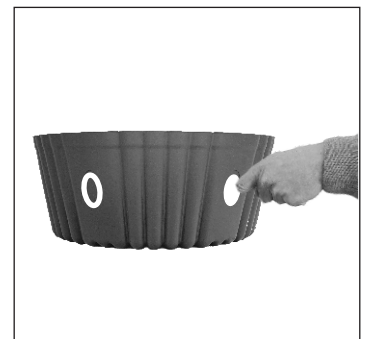

Optional:
Knock-Outs for Side Planting

CAUTION: Always remove planter before loosening or adjusting SmartStrap™

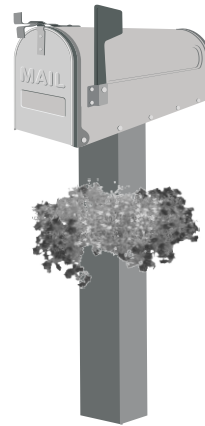
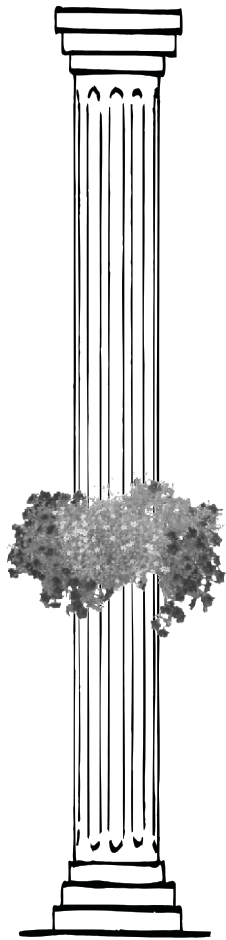
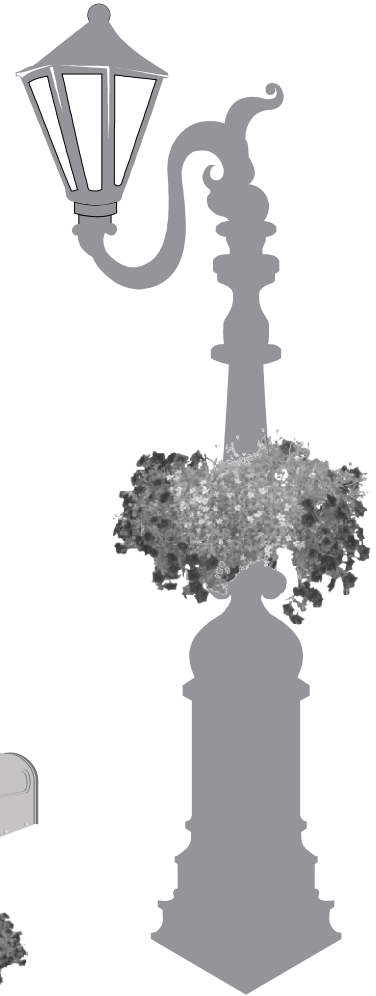
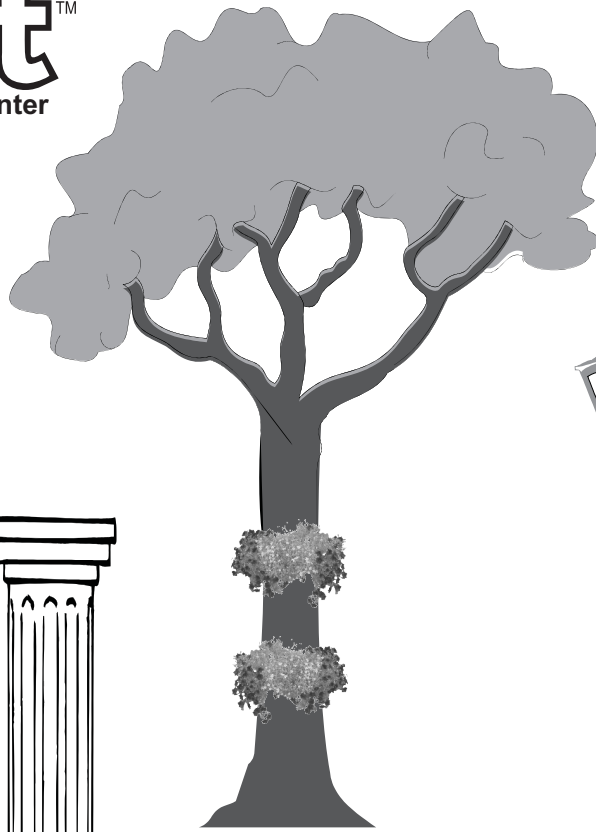
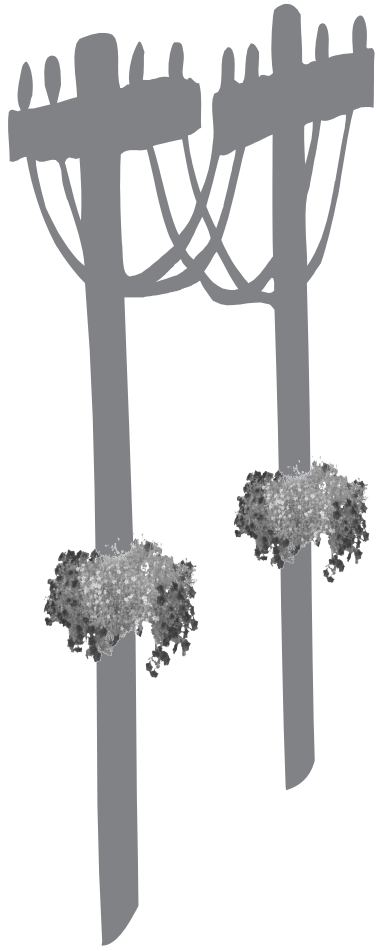
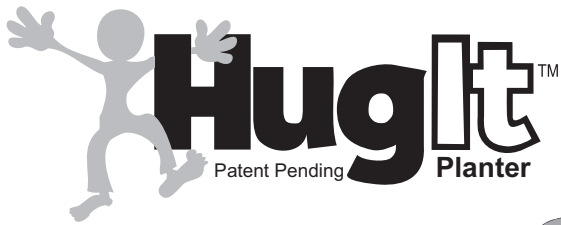

Instructions:

1. Always remove planter before loosening or adjusting SmartStrap™.
2. Do not flex planter box smaller than 6 inches diameter.
3. Check SmartStrap™ tension from time to time when mounted on living tree.
4. Do not flex or drop planter when frozen.
5. Product must be retrieved indoors during extreme weather unless already planted.

HugIt™ Planter is made in the USA with US and Imported Parts

WARRANTY/SERVICE

HugIt™ Planter is warranted to be free from manufacturing defects for a period of one year from the date of purchase by Garden-Aire, LLC., 206 W. Hardin Street, Findlay, OH, 45840. The following are not considered manufacturing defects and are excluded from coverage:

1. Damage caused by improper use or abuse
2. Fitness for use
3. Incidental or consequential damages

If you have a problem or discover a manufacturing defect, please call us at 888-424-2488. A representative of Garden-Aire will help you to resolve the problem, limited to providing you a replacement unit.